

MODEL

A01

● Black

● Red

● Blue

● Purple

● White



1 MATERIAL

- RoHS approved ChiMei Polycarbonate (Optional)
- UL/RoHS approved ChiMei Acrylate Styrene Acrylonitrile (Default)
- PC copolymer with enhanced UV stabilization Lexan Resin SLX2432T (Optional)
- Explosion-proof Carbon loaded ABS and flame resistant ABS material are available

2 SPECIFICATION

Waterproof Grade	IP65
Ambient Noise	≤60dB
SLR	5~15dB
RLR	-7~2dB
STMR	≥7dB
Working Temperature	-30℃ ~ +50℃
Relative Humidity	≤95%
Atmospheric Pressure	80Kpa-110Kpa
Certification	CE approved

3 RECEIVER

- Standard Receiver-Dynamic EA1503 (Default)
 - DC Resistance : $130\pm 10\%$ ohm
 - Frequency Response Range: 300 Hz-3400 Hz
 - Sensitivity: 95 ± 3 dB at 60mv
 - Impedance: $150\pm 20\%$ ohm at 1 KHz
- EA1509 high magnetic receiver (Optional)
 - MF Intensity Axial: -58 ± 2 dB at 1KHz 60mV, 0 dB=1 A/m
 - Frequency Response Range: 300 Hz-3400 Hz
 - Sensitivity: 100 ± 2 dB at 60mv
 - Impedance: $150\pm 20\%$ ohm at 1 KHz
- EA1512 hearing-aid receiver (Optional)
 - MF Intensity radial ≥ -22 dB at 1KHz, 0 dB=1 A/m
 - Frequency Response Range: 300 Hz-3400 Hz
 - Sensitivity: 98 ± 2 dB at 1 Hz 60mV
 - Impedance: $150\pm 20\%$ ohm at 1 KHz 60mV

4 DIMENSION DRAWING

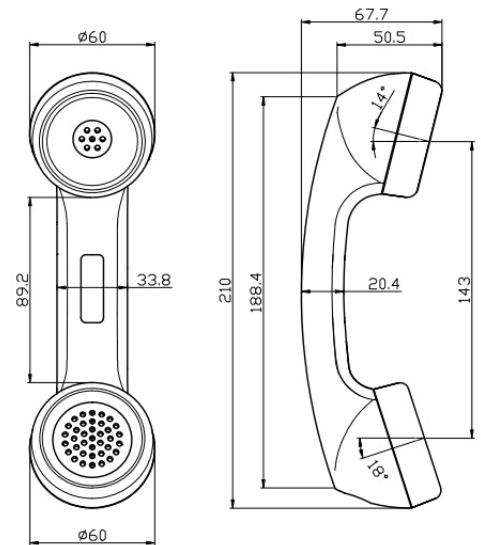

5 MICROPHONE

- Standard Microphone-Dynamic EA1503 (Default)
 - DC Resistance : $130\pm 10\%$ ohm
 - Frequency Response Range: 300 Hz-3400 Hz
 - Sensitivity: 95 ± 3 dB at 60mv
 - Impedance: $150\pm 20\%$ ohm at 1 KHz
- Dynamic 300 ohms, 600ohms microphone (Optional)
- A15T02 Noise Canceling microphone (Optional)
 - Frequency Response Range: 200 Hz-4000 Hz
 - Sensitivity: -65 ± 3 dB
 - Impedance: $10\pm 20\%$ ohm
 - Signal to Noise Ratio: ≥ 15 dB
- EB5421 Electret Microphone (Optional)
- EAOZ03 Carbon-equivalent Microphone (Optional)

6 STRUCTURE DRAWING

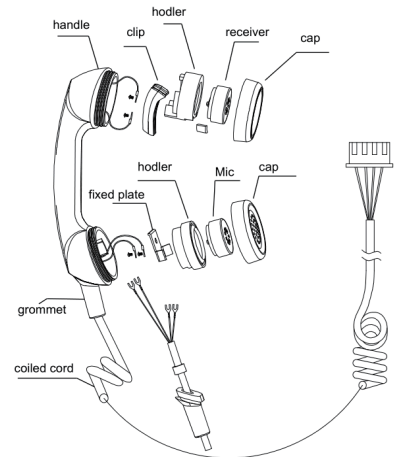

7 CORD

- PVC curly cord (Default)
 - Standard cord length 9 inch in retracted, 6 feet after extended (Default)
 - Customized different length is available.
- Weather resistant PVC curly cord (Optional)
- Hytel curly cord (Optional)
- SUS304 Stainless steel armored cord (Default)
 - Standard armored cord length 32 inch and 10 inch, 12 inch, 18 inch and 23 inch are optional.
 - Includes steel lanyard which is anchored to handset handle. Matched steel rope with different pull strength.
 - Dia: 1.6mm, 0.063", Pull test load: 170 kg, 375 lbs.
 - Dia: 2.0mm, 0.078", Pull test load: 250 kg, 551 lbs.
 - Dia: 2.5mm, 0.095", Pull test load: 450 kg, 992 lbs.

8 CONNECTOR

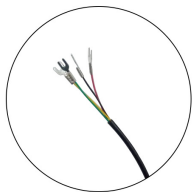

Y Spade

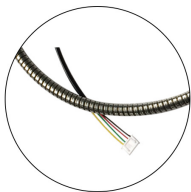

2.54mm XH Plug



2.0mm PH Plug



RJ Connector



3.5mm Two-audio Jack



Single Audio Jack

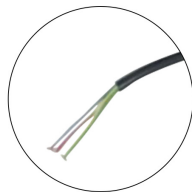

Bare Wire



Aviation Connector



Aviation Connector



Aviation Connector

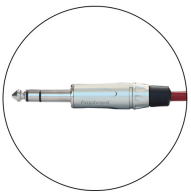

6.35mm Audio Jack



USB Connector

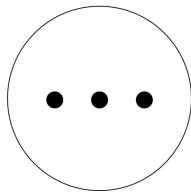

More

9 APPLICATION

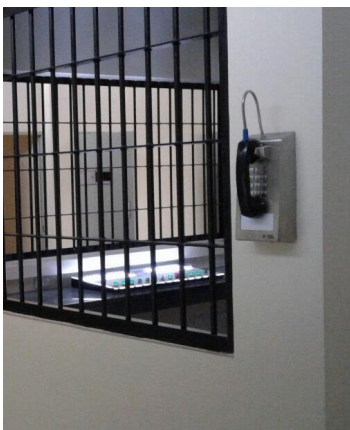

This handset is mainly for access control system telecommunication, industrial telephone, vending machine communication, security system and some other public facilities.

9 MATCHED CRADLE



C01: Zinc alloy hook switch



C12: Plastic hook switch



C13: Zinc alloy hook switch



C03: Plastic reed switch



C06: Zinc alloy metal switch



C11: Plastic reed switch